

# 29480 EM

## Dimensions

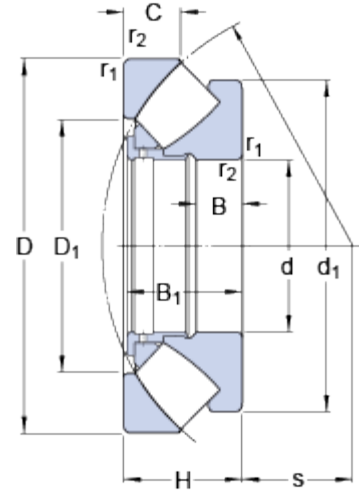

d	400	mm
D	710	mm
H	185	mm
d <sub>1</sub>	≈ 645	mm
D <sub>1</sub>	≈ 525	mm
B	69	mm
B <sub>1</sub>	178	mm
C	89.5	mm
s	234	mm
r <sub>1,2</sub>	min. 7.5	mm

## Abutment dimensions

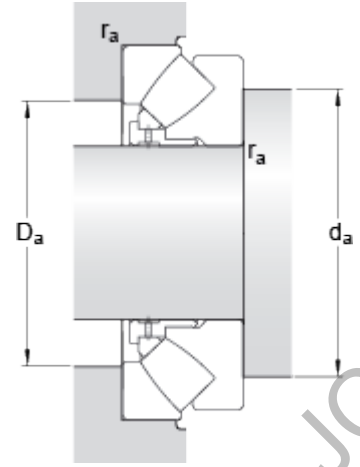

d <sub>a</sub>	min. 550	mm
D <sub>a</sub>	max. 615	mm
r <sub>a</sub>	max. 6	mm

## Calculation data

Basic dynamic load rating	C	7650	kN
Basic static load rating	C <sub>0</sub>	26500	kN
Fatigue load limit	P <sub>u</sub>	1960	kN
Reference speed		480	r/min
Limiting speed		850	r/min
Minimum axial load factor	A	62	

## Mass

Mass bearing		310	kg
--------------	--	-----	----